

The SUPER SKYRIDER
the hallicrafters
CHICAGO

WHAT DOES "COMMUNICATIONS RECEIVER" MEAN?

There still seems to exist in the minds of some that a *communications receiver* is just another name for *short-wave receiver*. A communications receiver *is* a short-wave receiver to be sure, but whereas the latter is fundamentally a broadcast receiver with extended ranges to include short-wave broadcast and possibly amateur stations, the former is a receiver especially designed for high frequency reception. The difference does not end here, however. The broadcast short-wave receiver is used solely for entertainment, whereas the communication receiver as used by the modern radio amateur is something far more than that. True an amateur gets pleasure out of working his transmitter and talking to friends the world over. But remember—his hobby is a scientific one, and the "air" is to him his laboratory. Amateur experimenting has contributed much in the way of radio advancement.

A communications receiver is therefore more than just a broadcast short-wave receiver. Their functions are entirely different. Where one will solely be used in the home for entertainment, the other may be operated under adverse conditions; in damp tropical surroundings, exposure to sea air or even the cold of the Arctic. Communications receivers must be solidly constructed and electrically fool-proof to stand up under such hard going, and the amateur must always be ready to turn from the role of experimenter to a much greater role when national emergencies—such as fires, floods, hurricanes—arise. It is therefore imperative that his equipment be trustworthy in such emergencies where the ability of the equipment to function properly may be the only means of obtaining aid in a stricken area. It must not fail.

And we, an organization devoted to the building of fine communications equipment well understand these facts, for many of us are old time amateur operators ourselves with stations of our own. Some of us operated our first transmitters twenty and more years ago, back in the days of spark transmitters and crystal detectors. Later, many of us were among the first amateurs to use the Lee Deforest Audion and we still remember the thrill we got out of our first regenerative receiver. Today finds us known as "*The Hallicrafters,*" building fine communications receivers. We take pride in our receivers; we believe they are the best we or anyone else can build.



★ AMERICA'S No. 1 COMMUNICATIONS RECEIVER

Even in this day of extravagant claims, we realize that it's taking in a lot of territory to say: "We sincerely believe that this is the finest all-round communication receiver on the market today!" Yet the new 1938 Super Sky Rider is designed to be just that.

We visualized a receiver tuning from 5 meters to the top of the broadcast band, with high sensitivity on all amateur bands (not merely the 20 or 10 meter band); wide range, variable selectivity (single signal razor sharpness to broad high fidelity); an effective, efficient band spread that would equal or better the standards set by the A.R.R.L. Handbook; improved image and signal to noise ratio, and finally, an "S" meter that would work on weak signals. It was a large order. But thanks to Mr. Karl W. Miles, and his competent staff, including Mr. J. L. A. McLaughlin, co-designer with Mr. James J. Lamb of the famous "dual diversity receiver"—every challenge was successfully met.

Of course, there are several other excellent receivers on the market today, but they cost considerably more than the new 1938 Super SKYRIDER . . . and even they do not offer the 5-meter band. Only ONE of them (at more than twice the price) offers variable selectivity and high fidelity. That's why we say—and you'll agree with us—that *here's America's No. 1 Communications receiver!*

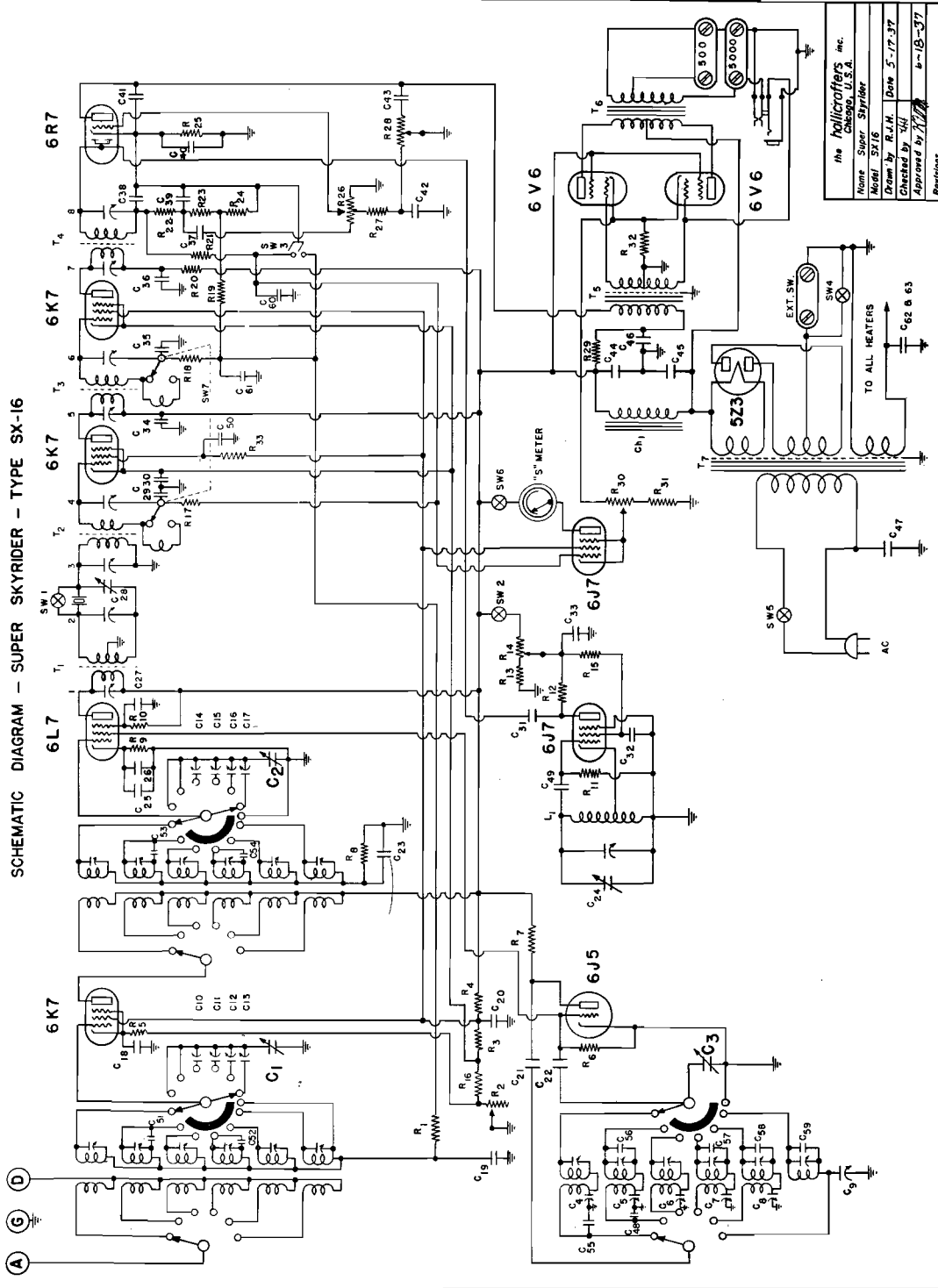

OPERATING INSTRUCTIONS

The 1938 Super SKYRIDER is a 6 band 11 tube superheterodyne receiver covering the following frequencies.

- Band No. 1— 545 KC to 1555 KC
- Band No. 2—1545 KC to 4300 KC
- Band No. 3—4.2 MC to 10.2 MC
- Band No. 4—9.8 MC to 20.5 MC
- Band No. 5—19 MC to 36 MC
- Band No. 6—35 MC to 62 MC

CURRENT RADIO PERIODICALS. IT IS SUGGESTED THAT A LITTLE EXPERIMENTING BE DONE WITH ANTENNAS SO THAT MAXIMUM PERFORMANCE WILL BE SECURED.

OPERATION

Plug the cord on the receiver into the power socket. (Unless otherwise specified the receiver operates on 60 cycle, 110 volt alternating current.) Turn the control marked "Tone" to the right. This will turn the receiver on. During the time the receiver is warming up also turn the "R.F. Gain" and "A.F. Gain" knobs to the right. The receiver is shipped with the band-change switch in the highest frequency range. Adjust the "Bands" switch until the pointer on the calibrated main dial indicates the band you wish to tune. We suggest that you familiarize yourself with the operation of the receiver on Bands No. 1 and No. 2 before trying the higher frequencies. Turn the large knob (directly below the silver dial) until the desired range is in the circuit. When listening for distant or possibly weak stations, it is recommended that the control marked "BFO INJECTION" be used by turning the knob to the right. Once these signals are located, it should be turned off or a continuous whistle will result. When listening to C.W. transmissions the control must be left turned on. The "PITCH CONTROL" knob will prove most helpful in changing the beat note to the one most pleasing to the operator. When "BFO INJECTION" control is "ON" the "AVC" switch should always be in the "OFF" position.

ANTENNA

In the back center of the chassis will be found the insulated antenna and doublet binding posts. If a doublet antenna is used, remove the jumper from the one insulated post to the chassis and connect the two wires from the doublet to the insulated posts. Please remember that the regular short wave doublet antenna is designed to work best on the short-wave broadcast frequencies. This means that it will not perform equally well on the amateur bands or frequencies in between the short wave broadcast channels. When using the conventional flat-top and lead-in type of antenna, connect the lead-in to the insulated post farthest to the left, being sure that the wire jumper is connected to the chassis and the other insulated post. Antenna location, length and type play a most important part in the successful operation of the set, especially on the three high frequency ranges. On the 5th and 6th bands it is particularly important to use the proper type of antenna. FOR MAXIMUM PERFORMANCE ON THE "ULTRA HIGH" FREQUENCIES YOU ARE REFERRED TO THE ANTENNA DESIGN SECTION OF THE A. R. R. L. HANDBOOK AND

PHONE RECEPTION

When receiving voice, whether broadcast or short wave, it is recommended that the "AVC" switch be left in the "ON" position. The "R.F. GAIN" control with "AVC" switch in the "ON" position should be turned as far as it will go to the right. It will be noticed that with the "AVC" switch "OFF" and the "R.F. GAIN" wide open the set will block on strong signals. If maximum sensitivity is desired the "AVC" switch can be left in the "OFF" position. The sensitivity may be manually controlled with the "R.F. GAIN" control. It will be found that by optional adjustment of both

Chart of Frequency Assignments in the Radio Spectrum Covered by the New Super Skyrider and conditions for Best Reception.

METERS	KILOCYCLES
545	550
BROADCAST BAND (B.C.)	
200	1,500
B. C. EXPERIMENTAL	
	1,600
POLICE FIRE MARINE, ETC.	
	1,715
AMATEUR CODE	
	1,800
160	2,000
AMATEUR PHONE	
	2,096
TELEVISION	
	2,208
SHIP HARBOR B. C. PICKUP, ETC.	
	2,500
POLICE	
	2,600
COASTAL HARBOR	
	2,750
AVIATION & GOV'T.	
	2,850
TELEVISION B. C. PICKUP	
	3,015
AVIATION & GOV'T.	
	3,265
SHIPS & COASTAL	
	3,410
	3,500
80	3,900
AMATEUR CODE	
	4,000
AMATEUR PHONE	
	4,800
GOVERNMENT PRESS SHIPS AVIATION POINT TO POINT EXP. COASTAL, ETC.	
	6,000
	6,150
49	6,700
AVIATION GOV'T. POINT TO POINT SHIPS & COASTAL	
	6,700
RELAY B. C. EXP.	
	6,700
AVIATION EXP. GOV'T. SHIPS PRESS COASTAL	
	7,000
POINT TO POINT	
	7,300
40	7,300
AMATEUR CODE	
	8,200
POINT TO POINT & GOVERNMENT	
	8,200
EXP. PRESS GOV'T. SHIPS & COASTAL	
	8,700
POINT TO POINT GOVERNMENT	
	9,500
31	9,500
RELAY B. C. EXP.	
	9,500
POINT TO POINT & GOVERNMENT	
	11,000
MISCELLANEOUS	
	11,700
25	11,900
RELAY B. C. EXP.	
	14,000
AVIATION COASTAL GOVERNMENT POINT TO POINT	
	14,000
AMATEUR CODE & PHONE	
	14,400
20	15,090
POINT TO POINT	
	15,340
RELAY B. C. EXP.	
	15,340
19	17,760
AVIATION COASTAL GOVERNMENT POINT TO POINT	
	17,800
16	17,800
RELAY B. C. EXP.	
	21,440
14	21,540
POINT TO POINT GOVERNMENT	
	23,000
MISCELLANEOUS	
	28,000
EXPERIMENTAL & GOVERNMENT	
	29,000
AMATEUR PHONE	
	29,000
AMATEUR CODE	
	30,000
10	56,000
2-WAY POLICE EXPERIMENTAL TELEVISION GOVERNMENT	
7.2	80,000
5	80,000
AMATEUR PHONE & CODE	

BAND 1 Ability to receive distant stations increases with darkness.

Darkness is the greatest aid to distance reception, although greater distances can be accomplished in daylight than on the lower frequencies. "Skip effect" (inability to receive close transmissions depending upon conditions) becomes noticeable on the higher frequencies in this band.

BAND 3 Darkness becoming less of a contributing factor in reception over greater distances. "Skip effect" more pronounced at night. Under usual conditions nearby transmissions not heard and when audible seemingly distorted. Static is bothersome on this range during warm weather.

BAND 4 On this range more consistent distance reception can be had. During cold weather this range normally goes dead at nightfall. During warm weather it is usually open twenty-four hours a day and remarkable DX can be heard. Normally stations cannot be heard on this band unless they are at least 400 miles from point of reception.

BAND 5 This range is normally usable only during the daylight hours. Frequencies in this range are most affected by conditions. "Skip effect" limits reception to ground waves of nearby stations (15 or 20 miles) or those stations removed by at least 700 to 1000 miles from the point of reception.

BAND 6 Unless conditions are very freaky, the maximum distance to be received on this range rarely exceeds fifty miles. Signals over this relatively short distance are received equally well in daylight and darkness. So far, this highly experimental range has "opened up" over 50 miles only at night. Do not feel that the set is performing incorrectly if some 5 meter signals are unintelligible—to receive signals well on this band the signals themselves must be stable and amplitude, not frequency, modulated.

"R.F." and "A.F." gain controls the most favorable ratio of signal to noise will be secured. THE CARRIER INTENSITY METER will function only when the "AVC" switch is "ON" and the "R.F." gain control is completely "ON," or turned to the right as far as it will go.

ON THE BACK OF THE CHASSIS IS A SCREWDRIVER ADJUSTMENT FOR SETTING THE "CARRIER" METER. THIS CONTROL SHOULD BE ADJUSTED SO THAT THE METER READS "O" WITH THE "R.F." CONTROL ON FULL, THE "AVC" ACTION ON AND THE ANTENNA DISCONNECTED.

C.W. RECEPTION

For the reception of C.W. Signals, the "AVC" switch should be in the "OFF" position and the "BFO INJECTION" control turned on. Variation of this control changes the output of the beat oscillator. Weak signals which would normally be inaudible with a strong beat oscillator are easily copied with the control just on. Turning the knob as far as it will go to the right gives maximum beat oscillator output.

THE TUBE LINE-UP

- 6K7—Preselector, R.F. amplifier
- 6L7—1st Detector-mixer
- 6J5—Signal frequency oscillator
- 6K7—1st I.F. amplifier
- 6K7—2nd I.F. amplifier
- 6R7—2nd Detector; "AVC"; 1st Stage of audio
- 2-6V6's—Push-pull power output 2nd audio stage
- 6J7—Beat frequency oscillator
- 6J7—Signal indicator amplifier
- 5Z3—Full-wave rectifier

The 6K7 R.F. stage gives maximum gain in inverse relation to frequency and provides increased selectivity and a reduction of image.

The first detector-mixer is a 6L7. The output from the 6J5 signal frequency oscillator is electron coupled to the injector, or No. 3 grid, of the 6L7. Because no oscillator plate current flows in the 1st detector, the ratio of signal to noise is more favorable than that obtained in a composite tube, or in circuits where the cathodes of two tubes are tied together.

The 6J5 oscillator has separate coils for each band. Superior overall performance of the new Super SKYRIDER is in part due to the design of the

signal frequency oscillator. No harmonics of the oscillator are used on any of the bands.

The 6R7 second detector gives half-wave diode detection, "AVC" and the triode section of this tube is the first stage of audio amplification. The plate of this section of this multi-purpose tube is transformer coupled to the grids of the push-pull 6V6's.

The push-pull 6V6 stage running straight Class "A" delivers 13 watts of undistorted audio power. Before actually drawing any grid current the output is in the neighborhood of 18 watts.

The beat oscillator is a 6J7 electron-coupled to the diode section of the 6R7.

The high-current 5Z3 rectifier provides ample current for the complete receiver with its push-pull 6V6 audio output stage.

I.F. AMPLIFIER

All intermediate frequency transformers are of the iron-core type and resonate at 465 KC. The I.F. amplifying system in the new Super SKYRIDER is of the expanding type providing a width expanded of 20 KCS at 100 X resonant input. Because of this feature, it is convenient to use the receiver in the broad position when covering the band and looking for a call. Once located, the desired station can then be sharpened by switching to "SHARP" position. Fidelity of broadcast reception is materially improved with the I.F. amplifier "BROAD." This type of transformer has so definitely demonstrated its superiority over the air core type as to warrant its use in the new 1938 Super SKYRIDER. Tremendous gain, better signal to noise ratio, sharp or broad selectivity are but a few of the advantages of the iron-core system.

The crystal input transformer is made up of three coils so placed that a signal of maximum strength is impressed on the low impedance primary of the crystal output transformer. The crystal filter with its phasing condenser is inserted between those transformers. With proper adjustment of the phasing condenser single signal operation can be secured. When the crystal is shorted, or the crystal switch is in the "OUT" position, the signal is impressed directly on the crystal output transformer which feeds the grid of the 6K7 first I.F. stage.

The second and third I.F. transformers are similar and provide maximum stabilized gain. The use of four iron-core I.F. transformers gives an order of

gain and selectivity which has heretofore never been obtained in communication receivers.

SPEAKER, HEADPHONE, ETC.

On the lower right hand corner on the back of the chassis you will find a terminal strip marked 5000 ohms. To this strip connect the permanent magnet speaker. The terminal strip marked 500 ohms directly above the 5000 ohm strip can be connected to a load of that impedance. The other terminal strip to the right of these two and marked "External Switch" is used to turn the set on or off for stand-by during transmissions. This strip when connected to a relay on the transmitter or a separate set of contacts on an external switch will turn the set on and off temporarily by opening the "B" supply to the receiver when the "Send-Receive" switch on the front panel is in the "Send" position.

In this receiver the speaker is not a portion of the filter system. This allows the receiver to be operated independently of the speaker itself. A permanent magnet 5000 ohm speaker capable of handling 18 watts is the type we recommend being used with this receiver.

The headphone jack is connected to the plate of the 6R7 through a condenser. The possibility of shock to the operator is eliminated by having no direct current on the phones. Crystal type headphones can be used on this receiver without using a special coupling transformer.

The total consumption of power by this receiver is 110 watts at 115 volts 60 cycle A.C.

CRYSTAL OPERATION

To properly adjust the crystal circuit for best performance the following procedure should be carefully followed.

Be sure that the "BFO INJECTION" control is in the "OFF" position.

Tune to some station transmitting continuously, being very careful to get the signal on the nose. After you are sure you have the signal resonated perfectly, turn on the "BFO INJECTION" control to nearly maximum position.

Check your tuning and be sure you still have the signal perfectly tuned-in.

Now change the "PITCH CONTROL" being sure that it is operating properly. Proper operation

of this control will be indicated by hearing the signal twice in one complete rotation of the knob, there being two positions in which no signal will be heard. These are known as the "zero beat" positions.

Snap the crystal switch to the "ON" position. You will notice a great reduction in noise. Carefully retune the signal on the "BAND SPREAD" dial. Notice how sharply the signal peaks, with normal volume again obtained. Now tune through the signal and find which side of the signal is the weaker. Tune in the weaker side and then carefully adjust the "PHASING" condenser control until the weaker signal is inaudible. Retuning to the other side of the signal should find no change in its volume and knife-like selectivity resulting. Whichever side of the zero-beat adjustment of the "PITCH CONTROL" gives the greater rejection of the interfering signal, that is the adjustment to be used for maximum selectivity. The phasing condenser affects the selectivity of the receiver whether the crystal is in the circuit or not. The crystal may be used in the reception of phone signals with some sacrifice in their quality.

Again you are reminded to tune this receiver with care. Because of its extreme selectivity, you may expect the most satisfactory results only after familiarizing yourself with its operation.

MAKING USE OF THE VERNIER SCALE

By means of the vernier scale, the main dial may be read and reset to one tenth of a division with an accuracy of one part in two thousands.

The three pictures on the right hand page illustrate the correct readings for three typical settings. The fraction of the whole number is always that division on the vernier scale which lines up with a division on the main dial. Take for example the first illustration:—

The zero on the vernier scale indicator falls between 169 and 170, so the whole number will be 169 and the fraction will be found by glancing along the vernier scale until a division on it lines up with one on the main dial. In this case it is 7 so the correct reading is $169 + 0.7 = 169.7$.

The number 170 in the middle illustration falls exactly under the zero indicator and the proof of this is that 10 on the vernier scale is the only division which lines up with a division on the main dial—actually the correct reading is $169 + 1.0 = 170$ and NOT $170 + 1.0$.

The third illustration shows the correct reading for 170.3.

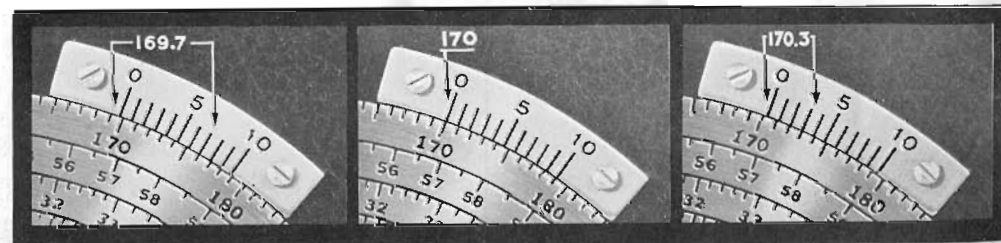
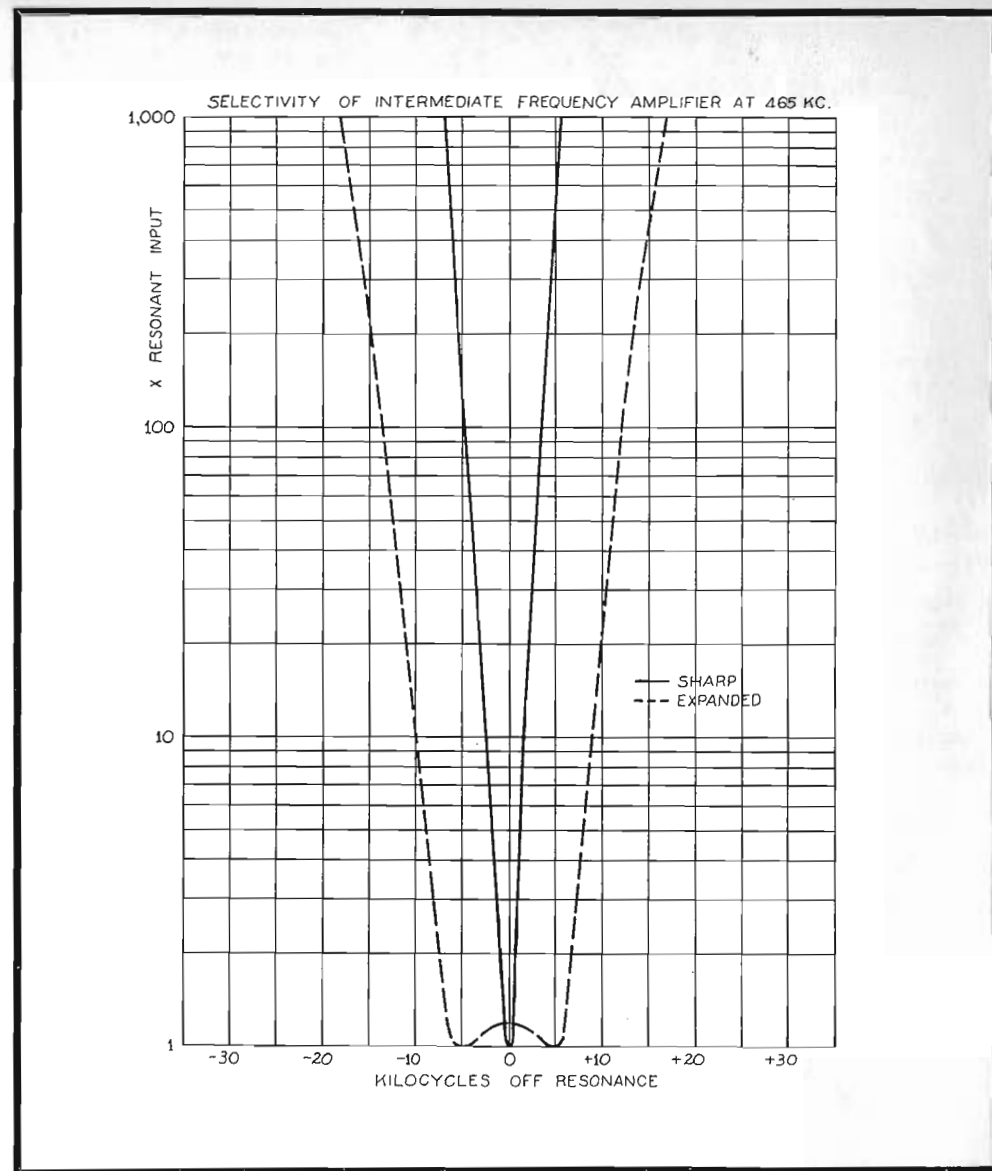

Look at these Features

ELECTRO-MECHANICAL BAND SPREAD ★

An exclusive Super Skyrider feature! Gives 1000° of Band Spread better than 5 KC per division on the 20 meter band; proportional spread on other bands. Special high frequency condenser with double rotors and single stator units makes the band spread section of the tuning unit an integral part of the main condenser.

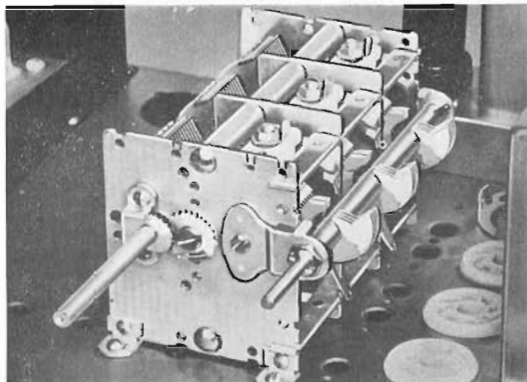

SIGNAL INTENSITY METER ★

Calibrated in "S" Signal calibration. Here's an "S" meter that will really work on weak signals. Large face . . . long scale. Unique indirect illuminated meter dial. Properly damped for tuning ease. Its just one more reason why Hams the world over will applaud this 1938 Super Skyrider Receiver!



THE ONLY TUNING DIAL OF ITS KIND! ★

There's one physical feature alone that distinguishes the Super Skyrider from all other receivers—the central tuning dial. Accurately, directly calibrated for all six bands . . . no charts or graphs needed to read this dial. Automatic band pointer . . . always indicates the frequency band on which you are tuning.

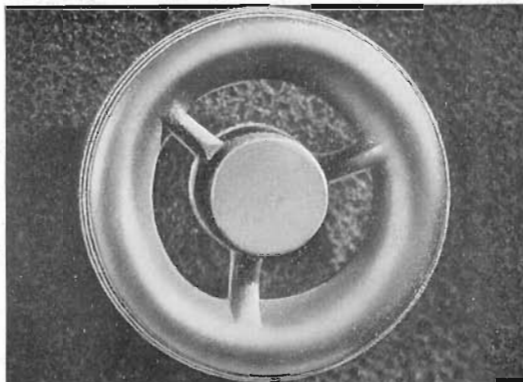
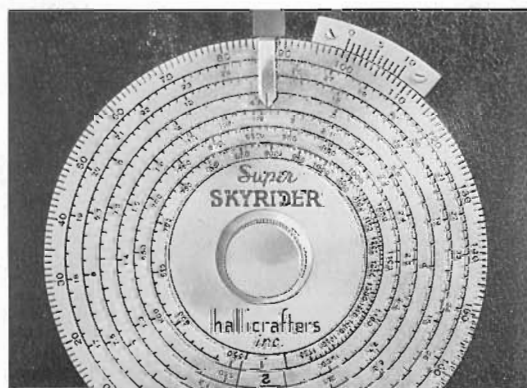

★ INERTIA TUNING

A single flip of the big, easy-grip knob and you cover half the band. Slow, sure, smooth tuning on band spread adjustment. Large knobs easy to handle; eliminate "tuning cramps" and fatigue. A feature that's bound to find favor with both the old timer and the new Ham. Found only on the Super Skyrider!

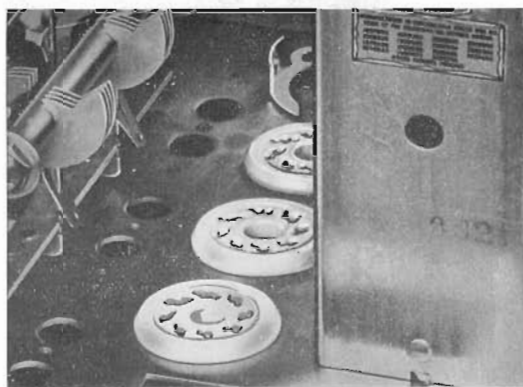

★ CERAMIC INSULATION

Ceramic (low loss insulation) in tuning tank circuits and R.F. sockets. On high frequencies, it is absolutely necessary to use the finest insulation possible. Ceramic was chosen, not only for its low loss qualities, but because it is non-hydroscopic. Retains its high efficiency under all climatic conditions.

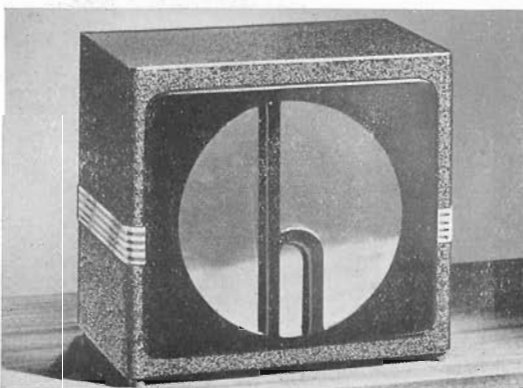

★ LARGE MATCHING HALLI-CRAFTERS SPEAKER

12-inch PM Dynamic speaker. Impedance matches receiver output to produce high fidelity audio. Metal cabinet acoustically treated with wood baffle front to eliminate vibration. Customary high quality Halli-crafters construction; sleek modern lines match the modern design of the 1938 SUPER SKYRIDER cabinet.

Parts Placement in SX-16

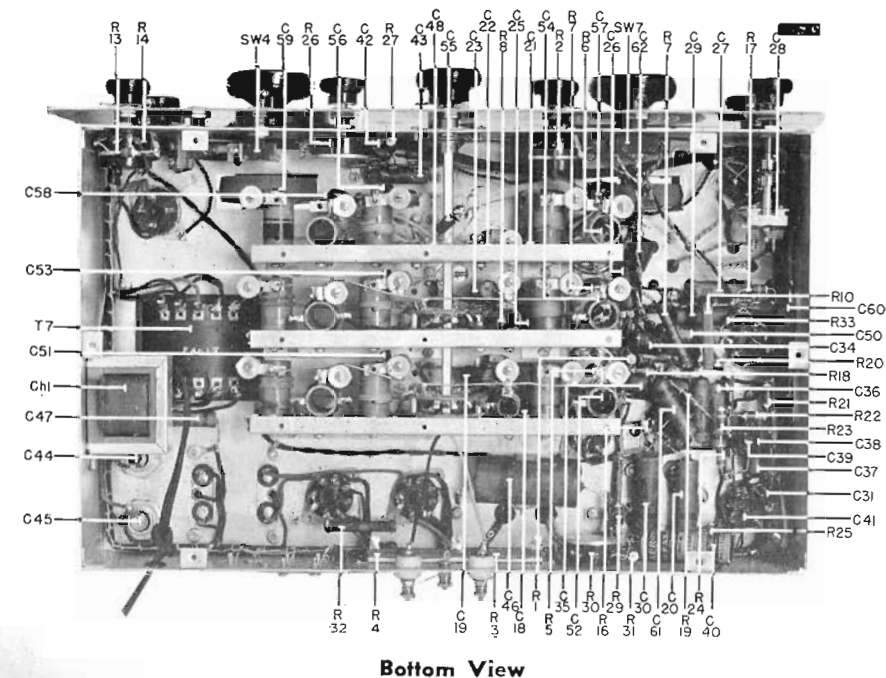
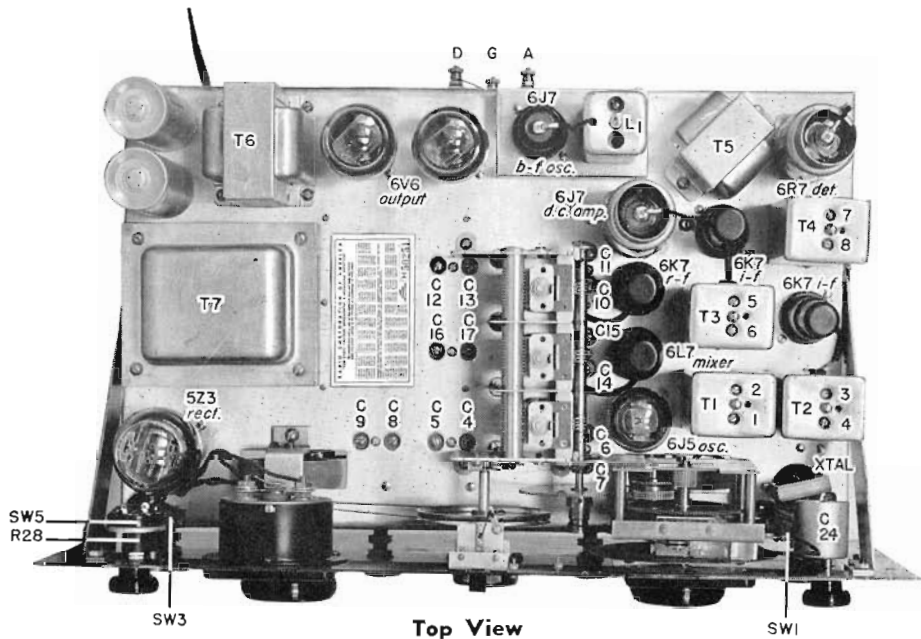

PARTS LIST CONDENSERS

No.	Capacity	Type	Voltage	Parts No.	No.	Capacity	Type	Voltage	Parts No.		
C ₁	420 mmfd	Main Gang		48017	C ₃₇	.05 mfd	Mica	200	41004		
C ₂	420 mmfd				C ₃₈	100 mmfd			40007		
C ₃	420 mmfd				C ₃₉	100 mmfd			40007		
C ₄	100 mmfd				C ₄₀	10. mfd			Electrolytic	25	42009
C ₅	100 mmfd				C ₄₁	.0005 mfd			Mica		43008
C ₆	310 mmfd				C ₄₂	.005 mfd				600	45003
C ₇	880 mmfd				C ₄₃	.02 mfd				400	41003
C ₈	1,400 mmfd				C ₄₄	16. mfd			Electrolytic	400	42019
C ₉	590 mmfd				C ₄₅	16. mfd			Electrolytic	400	42019
C ₁₀	1,000 mmfd				C ₄₆	1. mfd				400	41013
C ₁₁	350 mmfd	C ₄₇	.01 mfd		400	41001					
C ₁₂	180 mmfd	C ₄₈	.000050 mfd	Mica		40009					
C ₁₃	120 mmfd	C ₄₉	.00025 mfd	Mica		40007					
C ₁₄	1,000 mmfd	C ₅₀	.05 mfd		400	41005					
C ₁₅	350 mmfd	C ₅₁	.000010 mfd	Mica		40021					
C ₁₆	180 mmfd	C ₅₂	.000010 mfd	Mica		40021					
C ₁₇	120 mmfd	C ₅₃	.000010 mfd	Mica		40021					
C ₁₈	.002 mfd	Mica	200	40013	C ₅₄	.000010 mfd	Mica		40021		
C ₁₉	.05 mfd			41004	C ₅₅	.000050 mfd	Mica		40022		
C ₂₀	.1 mfd	Mica	400	41007	C ₅₆	.000010 mfd	Mica		40021		
C ₂₁	.002 mfd			40013	C ₅₇	.000010 mfd	Mica		40021		
C ₂₂	.0001 mfd	Air	200	40003	C ₅₈	.000010 mfd	Mica		40021		
C ₂₃	.05 mfd			41004	C ₅₉	.000025 mfd	Mica		40024		
C ₂₄	.000025 mfd	Mica	200	48012	C ₆₀	.05 mfd		200	41004		
C ₂₅	.002 mfd			40013	C ₆₁	.05 mfd		200	41004		
C ₂₆	.05 mfd	Air	400	41004	C ₆₂	.002 mfd	Mica		40013		
C ₂₇	.05 mfd			41005	C ₆₃	.002 mfd	Mica		40013		
C ₂₈	.000025 mfd	Mica	200	48012	S ₁	Crystal Switch SPST					
C ₂₉	.05 mfd			41004	S ₂	Beat Osc. Switch on B.F.O. Injection Control					
C ₃₀	.25 mfd	Mica	400	41008	S ₃	A.V.C. Switch DPST					
C ₃₁	.000010 mfd			40021	S ₄	Send-Receive Switch SPST					
C ₃₂	.01 mfd	Mica	400	41001	S ₅	A.C. Switch on Tone Control					
C ₃₃	.01 mfd			41001	S ₆	Meter Switch on R.F. Gain Control					
C ₃₄	.05 mfd	Mica	200	41005	S ₇	Selectivity Switch DPDT					
C ₃₅	.05 mfd			41004							
C ₃₆	.05 mfd		400	41005							

RESISTORS

No.	Ohms	Wattage	Part No.	No.	Ohms	Wattage	Part No.
R ₁	100,000	1/8	20093	R ₁₈	100,000	1/8	20093
R ₂	5,000		25021	R ₁₉	1,000,000	1/8	20108
R ₃	10,000	2.5	24037	R ₂₀	1,000	1/8	20033
R ₄	10,000	2.5	24037	R ₂₁	1,000,000	1/8	20108
R ₅	285	1/8	22020	R ₂₂	20,000	1/8	20072
R ₆	50,000	1/8	20084	R ₂₃	100,000	1/8	20099
R ₇	10,000	1.	20061	R ₂₄	100,000	1/8	20099
R ₈	100,000	1/8	20093	R ₂₅	950	1/8	22032
R ₉	285	1/8	22020	R ₂₆	1,000,000		25023
R ₁₀	29,000	1.	22075	R ₂₇	20,000	1/8	20072
R ₁₁	50,000	1/8	20084	R ₂₈	1,000,000		25013
R ₁₂	50,000	1/8	20084	R ₂₉	10,000	1/8	20063
R ₁₃	50,000	1/8	20084	R ₃₀	500		25022
R ₁₄	500,000		25024	R ₃₁	95	1/2	22007
R ₁₅	100,000	1/8	20093	R ₃₂	235	1.	22015
R ₁₆	380		22021	R ₃₃	1,000	1/8	20033
R ₁₇	100,000	1/8	20093				

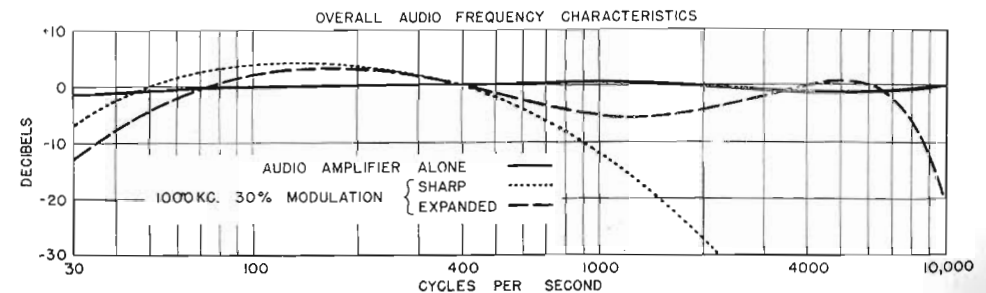

Here and there with Skyriders



During the flood disasters of last winter, amateur radio again played an heroic role. **Above**—handling flood traffic with a SUPER SKYRIDER at NDS, U. S. Naval Reserve Armory, Chicago. **Right**—Lt. Comm. Mathews (USNR) looks on at Flood Control Station, W9NLP, where a SKY CHIEF and SUPER SKYRIDER are seeing service.



"Ultramodern as well as ultra short wave" says *Popular Mechanics* of the ULTRA SKYRIDER. Photo below shows receiver in operation in the shielded testing room of Popular Mechanics radio laboratory.



As part of their regular headquarters equipment, the crack Flint (Mich.) Police Dept. relies on an ULTRA SKYRIDER.

NEW YORK WORLD-TELEGRAM, SATURDAY, APRIL 17, 1937.

Up Among the Megacycles

Short Wave Set Meets Test When Yugoslavian Diplomats Arrive Seeking Program Broadcast in Belgrade.

By TED ROGERS

With warm weather coming on (Okay! Let's not get technical) things are picking up noticeably on the 19 and 25-meter bands, and while 31 meters still continue to produce excellent results for the DX hunter, the 49-meter sector is slumping rapidly.

Owing to the vast preponderance of South Americans

on the 49-meter band this territory has been pretty much neglected by the average listener throughout the winter, when it is supposed to be at its best; after all, who wants to mess around with a band that offers nothing but rhumbas and tangos, all played by the same three-piece orchestra consisting of drum, guitar and flute, and with never a word of announcement in English?

Visited by Diplomats.

On Wednesday evening I was honored to entertain B. P. Stoyanovitch, Consul General of Yugoslavia, and his staff while we listened to a special broadcast up among the megacycles from Belgrade.

With a battery of five communications receivers which had been warming up for hours, I sat down, full of confidence and started spinning dials. Well, maybe not confidence, exactly, but hope, anyway. But imagine my embarrassment when minutes passed and we logged practically everything in the world except Belgrade.

At the end of about fifteen minutes we tried in a speech in an unfamiliar language, and immediately Mr. Stoyanovitch burst forth in happy smiles. It was the voice of the Consul General of Yugoslavia and the receiver that the trick was the old reliable SK11 superskyrider. After trying for a few minutes to log on to the other receivers, just by way of something to fall back on in case of emergency, but having no luck, we turned off the others and sat back to listen. And if you don't think a terrible weight was lifted from my brow when the skyrider did its stuff, then you never had eleven officials of a foreign nation standing skeptically by while you try to produce results in short wave radio reception.

Identified as Berlin. carrier wave has been our F

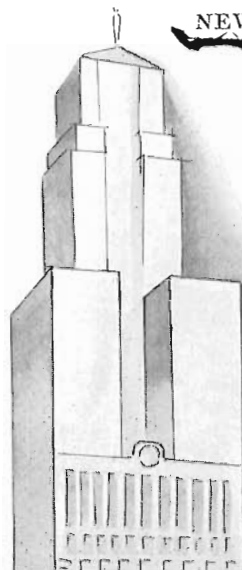

The "radio club in the sky," W9ZBX, atop the Board of Trade Building, Chicago. Note the ULTRA SKYRIDER in use.



COUNT FELIX von LUCKNER, famous World War hero, enjoys the SKY CHIEF at the home of BARONESS von BONIN in Berlin, Germany.



Other Members of the

Hallicrafters Family

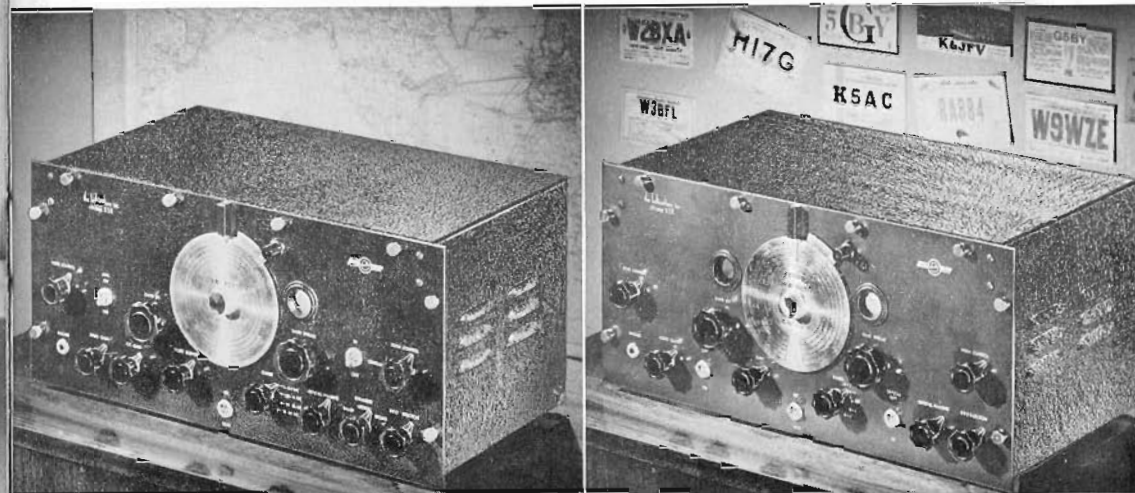

★ the Sky Challenger

The most talked about communications receiver in amateur radio! The SKY CHALLENGER has everything that present day practice demands for efficient high frequency reception. It will outperform any receiver in its price class and many costing much more. Extreme tuning range—38 MC to 535 KC (7.9 to 540 meters). Covers all the active amateur bands including the increasingly popular 10-meter band, the regular broadcast, short wave broadcast, police and aviation. Tuning is made remarkably easy with a smooth electrical band spread and 5 band 338° dial. Solid mechanical construction for steadier signals. Sensitivity and selectivity better than many higher priced communications receiver.

JUST CHECK THESE MANY TECHNICAL FEATURES: Iron core I.F. transformer (2 stages). Air trimmed R.F. Preamplifier. Direct calibration tuning—no charts—no tables. Automatic Volume Control. Beat Frequency Oscillator. Tone Control. Send-Receive (Standby) Switch. Headphone Jack. Hum Free Power Supply. Undistorted power output—4 watts. 9 tubes, 6 metal—3 glass: 6K7—RF-Preamplifier; 6L7—Mixer; 6C5—oscillator; 6K7—1st RF stage; 6K7—2d RF stage; 6Q7G—2d detector, AVC and 1st AF stage; 6F6G—Power Output Stage; 80—rectifier; 6K7—Beat Frequency oscillator. Size: $8\frac{3}{16}$ by $18\frac{1}{8}$ by $10\frac{1}{4}$ in. deep. Ship. wt. 37 lbs. For 110-120 volt, 60 cycle A.C.

★ the Ultra

Tune in 5 meter stations with no more trouble than you'd find on lower frequencies. Direct dial calibration—not charts or tables. Unique electro-mechanical band spread system. Image frequency rejection achieved by choosing an I.F. of 1600 KC. Band expander circuit can be cut in to reduce the bad "wabulation" typical of ultra high frequency transmission, by broadening the selectivity curve of the I.F. amplifier sufficiently to allow the carrier shift of the transmitter without attenuation.

Frequency range: 5.65 to 79.5 MC (3.75 to 53 meters). 4 band 338° calibrated illuminated dial—Band 1: 5.65 to 11.45 MC; Band 2: 10.5 to 21.35 MC; Band 3: 19.6 to 38.3 MC; Band 4: 36.4 to 79.5 MC. A.V.C. and tone control. Send-receive (standby) switch. Headphone jack. Preamplifier. Iron core I.F. transformers. Air trimmers. Single signal crystal control, beat frequency oscillator (variable input control). Undistorted power output of 3.5 watt, 10 metal tubes; 6K7, RF preamplifier; 6L7, 1st detector—Mixer; 6C5, oscillator; 6K7, 1st I.F. amplifier; 6L7, 2nd I.F. amplifier; 6R7, 2nd detector, AVC and beat frequency oscillator; 6J7, noise silencer amplifier; 6Q7, 1st audio, noise silencer rectifier; 6F6, power output stage; 5Z4, rectifier.

Size: $8\frac{3}{4}$ by 19 by 10 inches deep. Ship. wt. 45 lbs. For 110-120 V., 50-60 cycle A.C.

★ the Commercial

A special receiver covering in 5 bands the frequencies of 100 KC to 11.5 MC (3000 to 26.1 meters). Splendid sensitivity and selectivity characteristics. Improved image frequency rejection at the higher frequencies is achieved by the use of highly efficient iron core I.F. transformers tuned to 1600 KC. Calibrated 338° main tuning dial eliminates all complicated charts and tables.

Illuminated dial. Preamplifier. Iron core I.F. transformers (two stages) tuned to 1600 KC. Air trimmers. Automatic volume control, and tone control. Signal strength indicator. Single signal crystal control. Beat frequency oscillator (variable input control). Send-receive (standby) switch. Headphone jack. Hum free power supply. Undistorted power output of 14 watts. 11 tubes, 10 metal, and 1 glass: 6K7, RF preamplifier; 6L7, 1st detector—mixer; 6C5, oscillator; 6K7, 1st IF stage; 6K7, 2nd I.F. stage; 6R7, 2nd detector, AVC and 1st A.F.; 6K7, electron coupled beat frequency oscillator; two 6L6's, push-pull power output stage; 5Z3, rectifier, and 6G5, signal strength indicator.

5 Bands: Band 1—100 to 280 KC; Band 2—250 to 610 KC; Band 3—600 by 1530 KC; Band 4—1715 to 4300 KC; Band 5—4300 to 11,500 KC. Size $8\frac{3}{4}$ by 19 by 10 inches deep. Ship. wt. 48 lbs. For 110-120 V., 50-60 cycle A.C.



★ *the Sky Chief*

A complete communication receiver with every control need for efficient reception. Remarkable sensitivity and selectivity made possible with a high gain iron core I.F. transformer, equal in performance to 2 conventional air core stages and specially designed pre-

amplifier. Added selectivity and image frequency rejection given by preselector ahead of the first detector. Variable beat frequency oscillator for CW and weak signal reception. R.F. and audio gain control. Automatic volume control and send-receive switch. Signal strength indicator. Illuminated main and band spread dial. Hum-free power supply affords quiet headphone operation. Rigid construction assures steady signals. Mechanical band spread. Built-in speaker. Headphone jack. Three bands, from 18 MC to 540 KC: Band 1—540 to 1700 KC; Band 2—1600 to 5400 KC; Band 3—5300 to 18000 KC. Seven tubes: 78—RF preamplifier, 6A7—detector-oscillator; 6F7—I.F. amplifier and beat frequency oscillator; 75—2nd detector, AVC and A.F. amplifier; 42—power output stage. Size: 8 $\frac{3}{4}$ by 17 $\frac{1}{4}$ by 10 inches deep. Shipping weight, 29 lbs. For 110-120 volt, 50-60 cycle A.C. operation.

★ *the Sky Buddy*

A real junior model communication receiver that's hard to beat in sensitivity and selectivity even when it's compared with higher priced sets! Look at these features—and then look at this price! Tuning from 545 KC to 18.1 MC (16.6 to 555 meters) in three bands. Band 1—545 KC to 1680 KC; Band 2—1680 to 5500 KC; Band 3—5500 to 18,100 KC. Single iron core I.F. stage and improved mechanical band spread (16 to 1). Direct calibration tuning eliminates complicated charts and tables. Illuminated main dial. Automatic volume control. Beat frequency oscillator. Headphone jack. Hum-free self contained power supply. Built-in speaker. 5 tubes: 6A7—1st detector-oscillator; 6F7—intermediate amplifier and beat frequency oscillator; 75—2nd detector, AVC and 1st audio amplifier; 42—power output stage; 80—rectifier.

Size: 17 by 7 $\frac{1}{2}$ by 8 $\frac{5}{8}$ inches deep. Shipping weight 20 lbs. For use on 110-120 volt, 50-60 cycle A.C. current.



NAVY DEPARTMENT
NINTH NAVAL DISTRICT
NAVAL COMMUNICATION RESERVE

February 12, 1937

Hallicrafters, Inc.,
Chicago, Illinois

Gentlemen:

I have just completed a detailed report to the Commandant relative to the work of members of this unit in the recent flood emergency in the lower Ohio River Valley, but I can hardly consider my report complete without a word to you on the exceptional results obtained with the Hallicrafters receivers under the most adverse and trying conditions.

Five of the Sky Riders were used at our strategic points in the flood zone. They received the acid test if any receiver ever did. Bounced around in army trucks, over detours in the flood area and juggled about in frail outboard motor boats, they arrived at their destinations none the worse for the shaking up.

Four of the Sky Riders are owned by members of this unit; the fifth was borrowed.

One of the sets owned by Deman Starnes, Radioman First Class, was set up in the National Guard message center at Eldorado, Illinois. Another set owned by Carl Beck, Radioman Second Class, saw more than two weeks active and continuous duty at portable station NDS2 at Ridgway, an important base for operations for both the National Guard and Naval Militia. A third Sky Rider, owned by Chief Radioman M. E. Overholt, did yeoman duty at Effingham, a relay point. The other two were located at Dixon, alternate control station for the Illinois Communication Reserve radio net and ICGS, alternate control station for the Centralia Unit.

Selectivity; quick band changing; tone control and calibrated dial made it possible to handle thousands of words of important relief messages with a minimum of effort. Thanks to good calibration of these receivers, the schedules went off like clock work, despite the fact that some points were on the police frequency, others on the naval reserve frequency of 2650 kilocycles and still others in the middle of the 80 meter CW band.

Sincerely yours,

L. W. Hill
L. W. Hill, Lt (jg) C-V(s) USNR
Commander Unit 7 Section 4.



the hallicrafters inc.
2611 INDIANA AVENUE
CHICAGO